

△ THE ARROW, MARKED ON SENSOR EXTERIOR INDICATES NORMAL FLOW DIRECTION. THE TRANSMITTER CAN BE CONFIGURED FOR NORMAL (FORWARD), REVERSED OR BI-DIRECTIONAL FLOW.

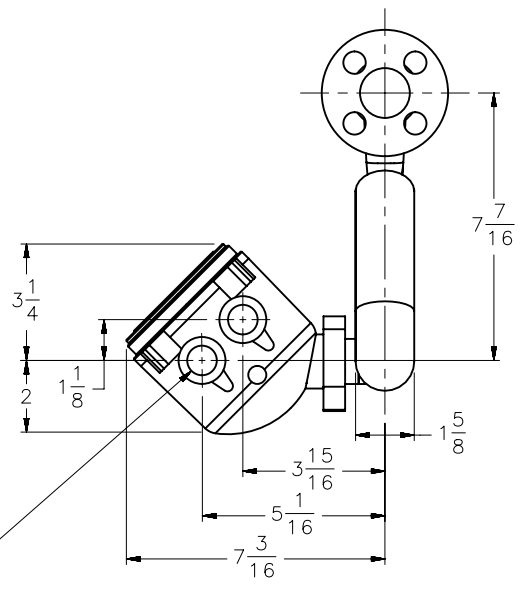

2X 1/2-14 NPT FEMALE
OR
2X M20 X 1.5 FEMALE

F O R I N F O R M A T I O N O N L Y

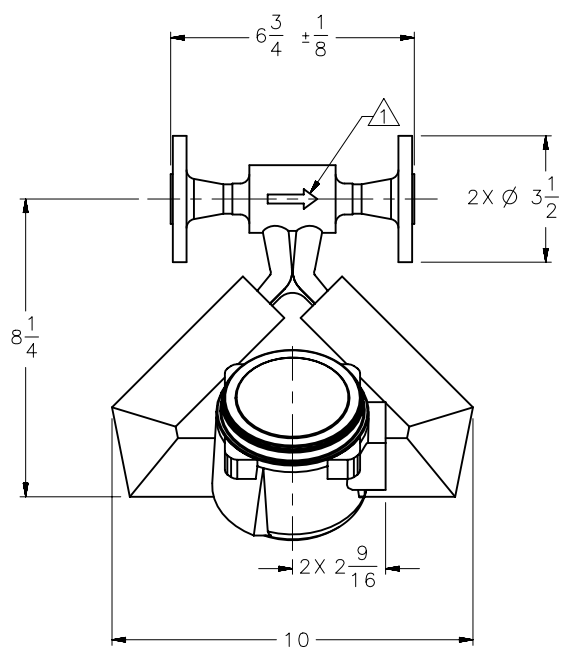

MODEL:
CMF025M313N2BAEZZZ

MICRO MOTION DIMENSIONAL DRAWING

DRAWN BY: PRG
REV:
DATE: July 22, 2021
DIMENSIONS ARE IN ENGLISH
DO NOT SCALE DRAWING

MATERIALS (WHERE APPLICABLE):
FLANGE: ASME B16.5 1/2IN CL150 WN RF F316/F316L
SENSOR: 316L / CF-3M STAINLESS STEEL; SENSOR CASE: 304L STAINLESS STEEL
ENCLOSURE: ENHANCED CORE, POLYURETHANE PAINTED ALUMINUM
ALLOWS FULL 360° ROTATION IN 45° INCREMENTS TO ORIENT WIRING CONDUIT OPENING

WEIGHT: 10 LBF

ADDITIONAL NOTES:

© Micro Motion / Emerson Process Management
For more information obtain a Product Data Sheet or Installation Manual at www.emersonprocess.com