

Cl.150, carbon steel, flange ASME B16.5
DN50 2"
LINER: Polyurethane

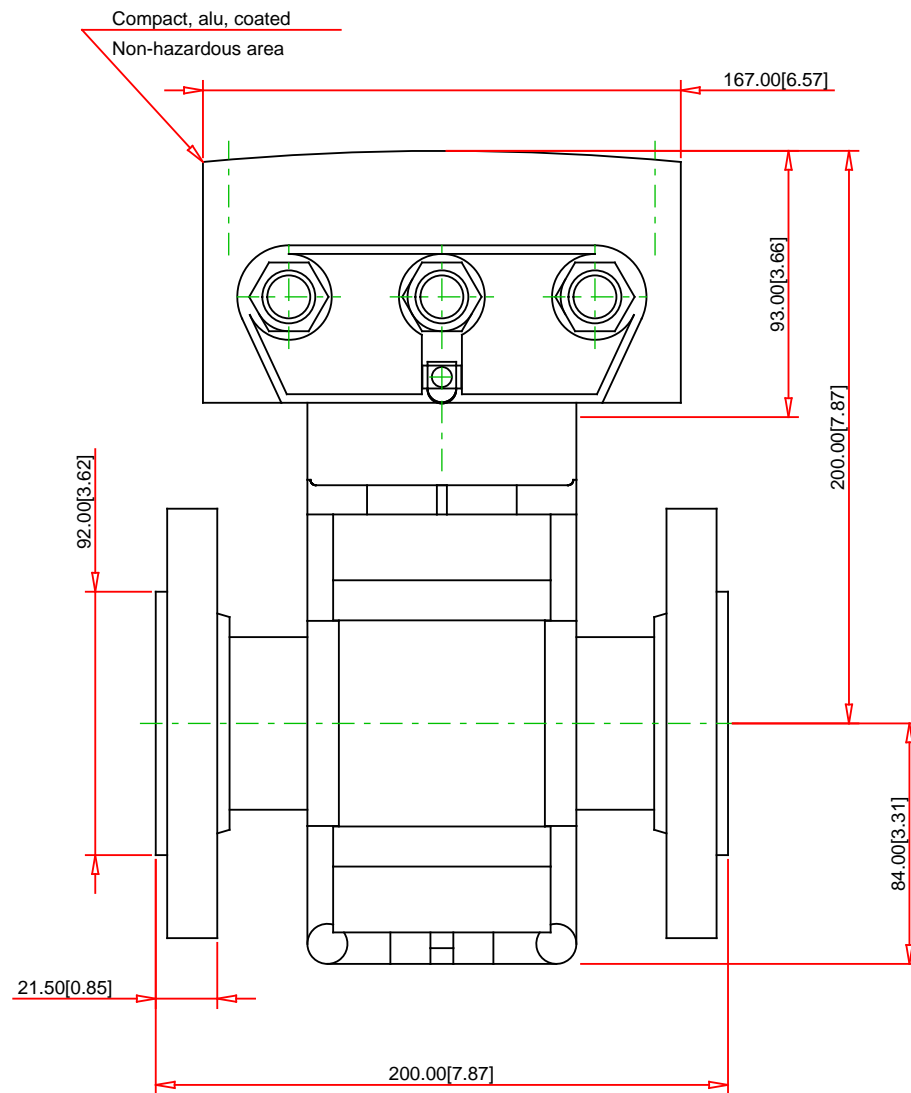

First Angle Projection XX.X [x.xx] = mm [inch]

Disclaimer:

To ensure the accuracy of the information contained in this document every reasonable effort has been made. Endress+Hauser may not make any warranties, express or implied, with respect to the accuracy, the completeness or the technical or commercial usefulness of this document. Endress+Hauser may modify or replace this document any time.

© 19.07.2021 Endress+Hauser

Order Code :
5W4C50-AAALHA0DUA1K0A

Product Description :
Promag W 400, 5W4C50, DN50 2"

www.addresses.endress.com

Endress+Hauser 

People for Process Automation